

• Attacco terzo punto: cat. 2 | *Type attelage: cat. 2*

• Slitte laterali regolabili | *Adjustable side skids*

• Rullo autopulente regolabile e smontabile
Self-cleaning adjustable and bolted roller

• Tendicinghia automatico e ingrassaggio centralizzato
Centralised greaser and automatic belt tightener

• Gruppo moltiplicatore con ruota libera interna
Gearbox with free wheel

• Spostamento idraulico laterale con sistema di bloccaggio meccanico
Hydraulic side offset with mechanical stop system

• Ammortizzatore e accumulatore oleopneumatico
Oleo-pneumatic shock absorber and accumulator

• Sicurezza meccanica | *Mechanical safety*

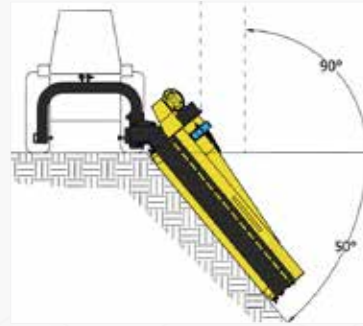

TORINO

TRINCIA LATERALE PROFESSIONALE | PROFESSIONAL SIDE MOWER

MOD : 160 | 180 | 200 | 220



UTENSILI | TOOLS

MAZZA
HAMMER



COLTELLO Y
Y FLAILS



ATTACCO TERZO PUNTO
THREE POINT HITCH

2° CAT.

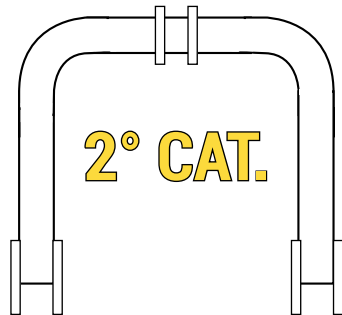

CARATTERISTICHE | FEATURES



Utensili | *Tools*



Accumulatore oleopneumatico
Oleo-pneumatic accumulator









Sicurezza meccanica
Mechanical safety



Rullo smontabile
Bolted roller

SPECIFICHE TECNICHE | TECHNICAL SPECIFICATIONS

	MODELLO MODEL	160	180	200	220
	LARGHEZZA LAVORO WORK WIDTH (cm)	160	180	200	220
	LARGHEZZA MACCHINA WIDTH MACHINE (cm)	185	215	227	245
	PESO WEIGHT	730	790	815	840
	N° MARTELLI e COLTELLI HAMMER and KNIFE	34 68	38 76	44 88	48 96
	N° CINGHIE SPBX BELTS SPBX	4	4	4	4
	SCATOLA STANDARD STANDARD GEARBOX	65-110		80-120	

	RIF.	160	180	200	220
SPOSTAMENTO LATERALE (cm) SIDE OFFSET (cm)	A	160	180	200	220
	B	195	195	195	195
	C	80	80	80	80
	D	215	235	255	275
	E	223	223	223	223
	F	135	135	135	135

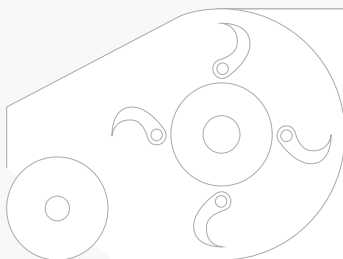

Ø del rotore Ø of rotor	180 mm
Giri rotore RPM	1800 g/min
Presa di forza PTO	540
Ø del rullo Ø of roller	177 mm

OMARV

Via Abbate 215, Castagnole delle Lanze 14054 (AT) - Italy
Tel. +39 0141 877368
info@omarv.com - www.omarv.com

OPZIONI & ACCESSORI | OPTIONS & ACCESSORIES

CARDANO 1700 mm | PTO SHAFT 1700 mm

CARDANO GRANDANGOLO 2200 MM (EUROCARDAN)
WIDE ANGLE PTO SHAFT 2200 MM (EUROCARDAN)

